

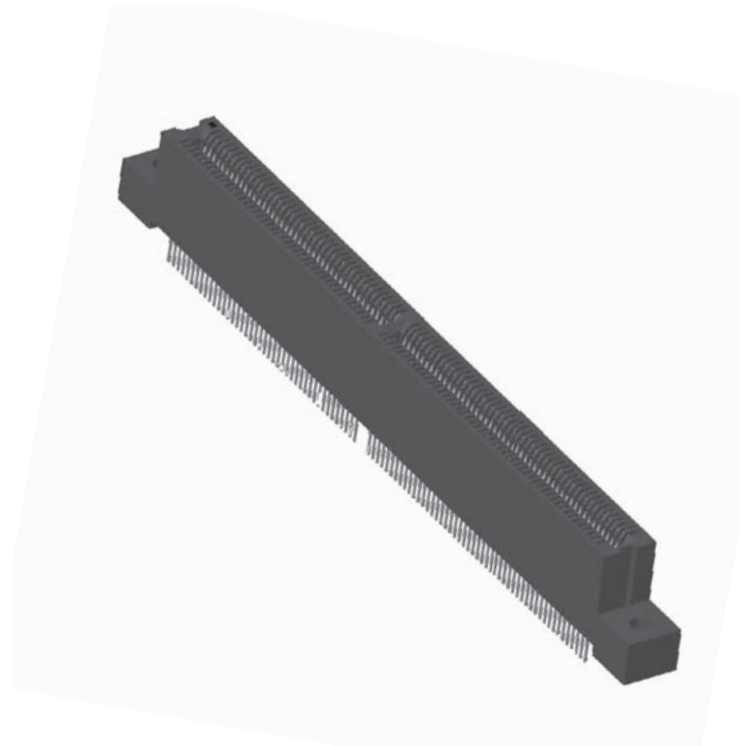

SPECIFICATIONS

- Accommodates .062" ± .008" [1.57 ± .20] PC board (Consult factory for other board thicknesses)
- PPS or PA9T insulator
- Molded-in key available
- High reliability/high cycle hairpin bellows contact
- 1 amp current rating per contact
- 150 grams normal force minimum



Sullins Edgecards

READOUT

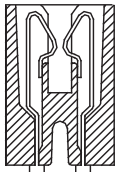

DUAL (D)

TERMINATION TYPE

Consult Factory for PC Board Layouts

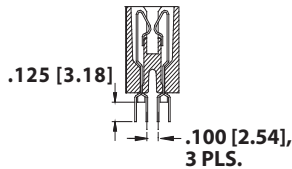

STAGGERED DIP SOLDER (HH)

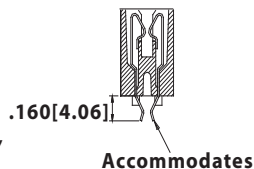

Accommodates .062 PCB
CARD EXTENDER (HR)

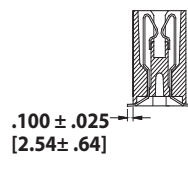

SURFACE MOUNT (HF)

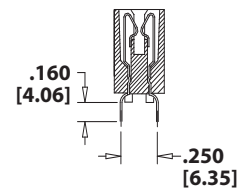

DIP SOLDER (HL)

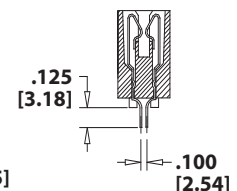

DIP SOLDER (HN)

MOUNTING STYLE

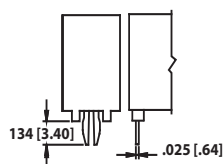

BOARD LOCK (R)
(with no mounting ears)



NO MOUNTING EARS (N)

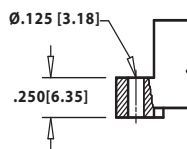

FLUSH MOUNTING (D)

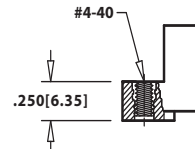

FLUSH MOUNTING WITH THREADED INSERT (T)

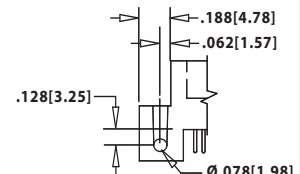

STRADDLE MOUNT (Q)



.050" [1.27 mm] Contact Centers, .610" [15.49 mm] Insulator Height [MCA] Dip Solder/Card Extender/SMT

Industry Standard Part

Sullins Edgecards

PART NUMBER OPTIONS

<p>MATERIALS (Insulator/Contact)</p> <p>G = PA9T/Phosphor Bronze R = PPS/Phosphor Bronze J = PA9T/Beryllium Copper A = PPS/Beryllium Copper</p> <p>CONTACT FINISH - RoHS Compliant</p> <p>All platings are Lead Free and have .000050" Nickel underplate</p> <p>Contact Surface Termination</p> <p>B = .000010" Gold .000100" Pure Tin, Matte C = .000030" Gold .000100" Pure Tin, Matte</p> <p>CONTACT CENTERS</p> <p>B = .050" [1.27mm]</p> <p>NUMBER OF CONTACT POSITIONS</p> <p>56, 66, 91, 106</p>	<p>G B B 56 D HH D - S578</p>	<p>MODIFICATION (Consult Factory)</p> <p>-S578 = Card Slot Barriers With Guide Posts -S621 = Card Slot Barriers Without Guide Posts</p> <p>MOUNTING STYLE</p> <p>N = No Mounting D = Flush Mounting T = Flush Mounting With Threaded Insert Q = Straddle Mount (Card Extender Only) R = Metal Board Lock</p> <p>TERMINATION TYPE</p> <p>HH = Staggered Dip Solder HR = Card Extender HF = Surface Mount HL = .250" [6.35mm] x .160" [4.06mm] Dip Solder HN = .100" [2.54mm] x .125" [3.18mm] Dip Solder <i>(REPLACES TERMINATIONS: CH, CR, CF, CL, CN)</i></p> <p>READOUT</p> <p>D = Dual</p>
---	--------------------------------------	---

DIMENSIONS

Dimensions in [] are in millimeters, all others are in inches.

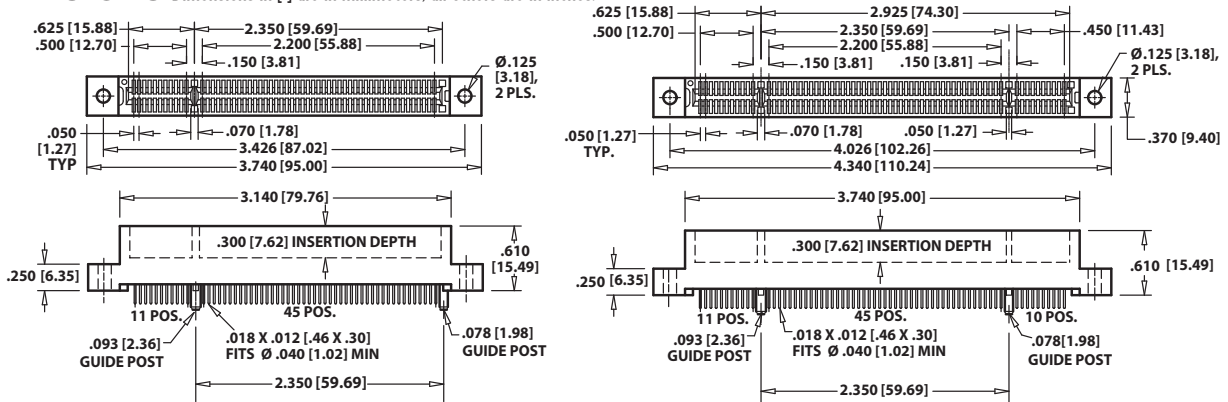

GBB56DHHD-S578, 56 (11/45) POSITIONS

GBB66DHHD-S578, 66 (11/45/10) POSITIONS

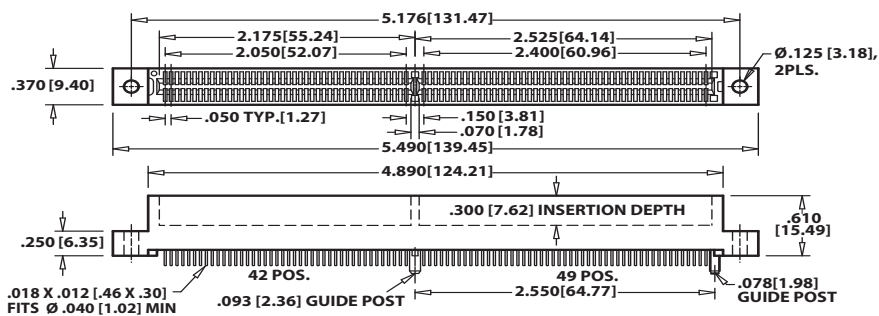

GBB91DHHD-S578, 91 (42/49) POSITIONS

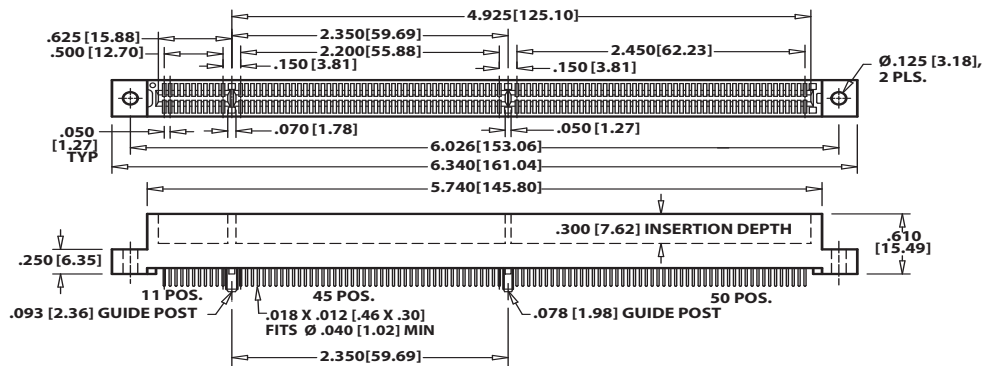

GBB106DHHD-S578, 106 (11/45/50) POSITIONS