

RoHS SIDACtor® Series - TO-92



Agency Approvals

Agency	Agency File Number
	E133083

Pinout Designation

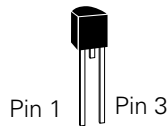

Schematic Symbol



Description

SIDACtor® Series TO-92 are designed to protect baseband equipment such as modems, line cards, CPE and DSL from damaging overvoltage transients.

The series provides a robust through-hole solution that enables equipment to comply with global regulatory standards.

Features and Benefits

- Low voltage overshoot
- Low on-state voltage
- Does not degrade with use
- Fails short circuit when surged in excess of ratings
- Low Capacitance

Applicable Global Standards

- TIA-968-A
- ITU K.20/21 Enhanced Level*
- ITU K.20/21 Basic Level
- GR 1089 Inter-building*
- GR 1089 Intra-building
- IEC 61000-4-5
- YD/T 1082
- YD/T 993
- YD/T 950

* A/B-rated parts require series resistance

Electrical Characteristics

Part Number	Marking	V_{DRM} @ $I_{DRM} = 5\mu A$	V_S @ 100V/ μs	I_H	I_S	I_T	V_T @ $I_T = 2.2$ Amps	Capacitance @ 1MHz, 2V bias	
		V min	V max	mA min	mA max	A max	V max	pF min	pF max
P0080EALxxx	P0080EA	6	25	50	800	2.2	4	25	150
P0300EALxxx	P0300EA	25	40	50	800	2.2	4	15	140
P0640EALxxx	P0640EA	58	77	150	800	2.2	4	40	60
P0720EALxxx	P0720EA	65	88	150	800	2.2	4	35	60
P0900EALxxx	P0900EA	75	98	150	800	2.2	4	35	55
P01100EALxxx	P01100EA	90	130	150	800	2.2	4	30	50
P1300EALxxx	P1300EA	120	160	150	800	2.2	4	25	45
P1500EALxxx	P1500EA	140	180	150	800	2.2	4	25	40
P1800EALxxx	P1800EA	170	220	150	800	2.2	4	25	35
P2300EALxxx	P2300EA	190	260	150	800	2.2	4	25	35
P2600EALxxx	P2600EA	220	300	150	800	2.2	4	20	35
P3100EALxxx	P3100EA	275	350	150	800	2.2	4	20	35
P3500EALxxx	P3500EA	320	400	150	800	2.2	4	20	35

Table continues on next page.

Electrical Characteristics (continued)

Part Number	Marking	V_{DRM} @ $I_{DRM} = 5\mu A$	V_S @ 100V/ μs	I_H	I_S	I_T	V_T @ $I_T = 2.2$ Amps	Capacitance @ 1MHz, 2V bias	
		V Min	V Max	mA Min	mA Max	A Max	V Max	pF Min	pF Max
P0080EBLxxx	P0080EB	6	25	50	800	2.2	4	25	150
P0300EBLxxx	P0300EB	25	40	50	800	2.2	4	15	140
P0640EBLxxx	P0640EB	58	77	150	800	2.2	4	40	60
P0720EBLxxx	P0720EB	65	88	150	800	2.2	4	35	75
P0900EBLxxx	P0900EB	75	98	150	800	2.2	4	35	70
P01100EBLxxx	P01100EB	90	130	150	800	2.2	4	30	70
P1300EBLxxx	P1300EB	120	160	150	800	2.2	4	25	60
P1500EBLxxx	P1500EB	140	180	150	800	2.2	4	25	55
P1800EBLxxx	P1800EB	170	220	150	800	2.2	4	25	50
P2300EBLxxx	P2300EB	190	260	150	800	2.2	4	25	50
P2600EBLxxx	P2600EB	220	300	150	800	2.2	4	20	45
P3100EBLxxx	P3100EB	275	350	150	800	2.2	4	20	45
P3500EBLxxx	P3500EB	320	400	150	800	2.2	4	20	40
P0080ECLxxx	P0080EC	6	25	50	800	2.2	4	35	260
P0300ECLxxx	P0300EC	25	40	50	800	2.2	4	25	250
P0640ECLxxx	P0640EC	58	77	150	800	2.2	4	55	155
P0720ECLxxx	P0720EC	65	88	150	800	2.2	4	50	150
P0900ECLxxx	P0900EC	75	98	150	800	2.2	4	45	140
P01100ECLxxx	P01100EC	90	130	150	800	2.2	4	45	115
P1300ECLxxx	P1300EC	120	160	150	800	2.2	4	40	105
P1500ECLxxx	P1500EC	140	180	150	800	2.2	4	35	95
P1800ECLxxx	P1800EC	170	220	150	800	2.2	4	35	90
P2300ECLxxx	P2300EC	190	260	150	800	2.2	4	30	80
P2600ECLxxx	P2600EC	220	300	150	800	2.2	4	30	80
P3100ECLxxx	P3100EC	275	350	150	800	2.2	4	30	70
P3500ECLxxx	P3500EC	320	400	150	800	2.2	4	25	65

Notes:
 - Absolute maximum ratings measured at $T_c = 25^\circ C$ (unless otherwise noted).
 - Devices are bi-directional (unless otherwise noted).
 - xxx part number suffix: 'AP' = Ammo Pack, 'RP1' and 'RP2' = Reel Pack, blank = Bulk Pack

Surge Ratings

Series	I_{PP}									I_{TSM} 50/60 Hz	di/dt
	0.2×310^1 0.5×700^2	2×10^1 2×10^2	8×20^1 1.2×50^2	10×160^1 10×160^2	10×560^1 10×560^2	5×320^1 9×720^2	10×360^1 10×360^2	10×1000^1 10×1000^2	5×310^1 10×700^2		
	A min	A min	A min	A min	A min	A min	A min	A min	A min		
A	20	150	150	90	50	75	75	45	75	20	500
B	25	250	250	150	100	100	125	80	100	25	500
C	50	500	400	200	150	200	175	100	200	30	500

Notes:
 1 Current waveform in μs
 2 Voltage waveform in μs
 - Peak pulse current rating (I_{pp}) is repetitive and guaranteed for the life of the product.
 - I_{pp} ratings applicable over temperature range of $-40^\circ C$ to $+85^\circ C$
 - The device must initially be in thermal equilibrium with $-40^\circ C \leq T_j \leq +150^\circ C$

Thermal Considerations

Package	Symbol	Parameter	Value	Unit
TO-92 	T_J	Operating Junction Temperature Range	-40 to +150	$^\circ C$
	T_S	Storage Temperature Range	-65 to +150	$^\circ C$
	$R_{\theta JA}$	Thermal Resistance: Junction to Ambient	90	$^\circ C/W$

V-I Characteristics

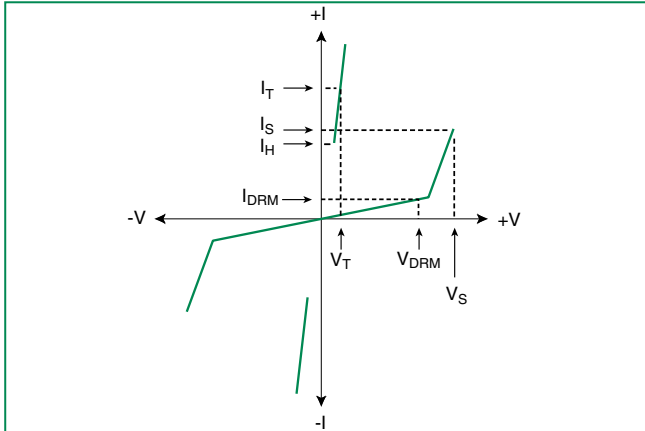

$t_r \times t_d$ Pulse Waveform

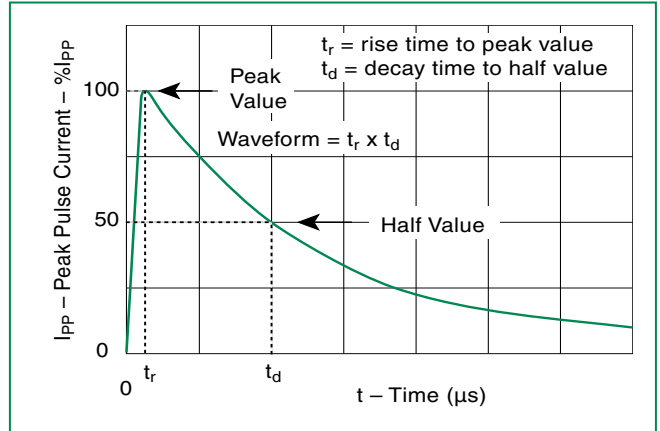

Normalized V_S Change vs. Junction Temperature

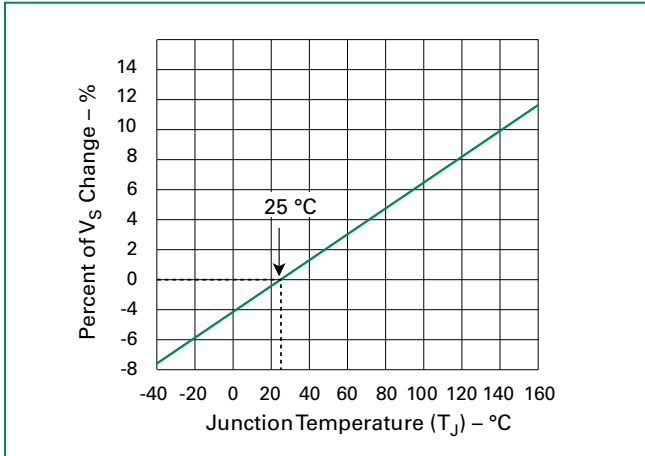

Normalized DC Holding Current vs. Case Temperature

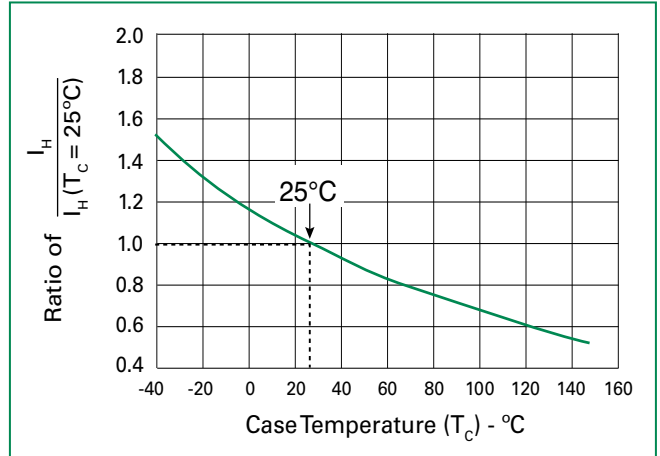

Soldering Parameters

Reflow Condition	Pb-Free assembly (see Fig. 1)	
Pre Heat	- Temperature Min ($T_{s(min)}$)	+150°C
	- Temperature Max ($T_{s(max)}$)	+200°C
	- Time (Min to Max) (t_s)	60-180 secs.
Average ramp up rate (Liquidus Temp (T_L) to peak)		3°C/sec. Max.
$T_{s(max)}$ to T_L - Ramp-up Rate		3°C/sec. Max.
Reflow	- Temperature (T_L) (Liquidus)	+217°C
	- Temperature (t_L)	60-150 secs.
Peak Temp (T_p)		+260(+0/-5)°C
Time within 5°C of actual Peak Temp (t_p)		30 secs. Max.
Ramp-down Rate		6°C/sec. Max.
Time 25°C to Peak Temp (T_p)		8 min. Max.
Do not exceed		+260°C

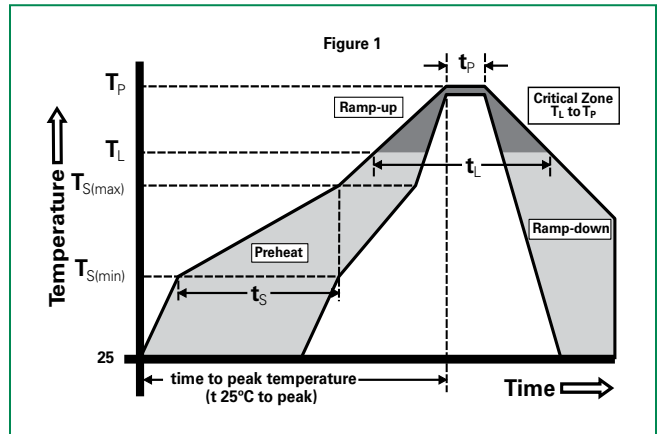

Physical Specifications

Lead Material	Copper Alloy
Terminal Finish	100% Matte-Tin Plated
Body Material	UL recognized epoxy meeting flammability classification 94V-0

Environmental Specifications

High Temp Voltage Blocking	80% Rated V_{DRM} (V_{AC} Peak) +125°C or +150°C, 504 or 1008 hrs. MIL-STD-750 (Method 1040) JEDEC, JESD22-A-101
Temp Cycling	-65°C to +150°C, 15 min. dwell, 10 up to 100 cycles. MIL-STD-750 (Method 1051) EIA/JEDEC, JESD22-A104
Biased Temp & Humidity	52 V_{DC} (+85°C) 85%RH, 504 up to 1008 hrs. EIA/JEDEC, JESD22-A-101
High Temp Storage	+150°C 1008 hrs. MIL-STD-750 (Method 1031) JEDEC, JESD22-A-101
Low Temp Storage	-65°C, 1008 hrs.
Thermal Shock	0°C to +100°C, 5 min. dwell, 10 sec. transfer, 10 cycles. MIL-STD-750 (Method 1056) JEDEC, JESD22-A-106
Autoclave (Pressure Cooker Test)	+121°C, 100%RH, 2atm, 24 up to 168 hrs. EIA/JEDEC, JESD22-A-102
Resistance to Solder Heat	+260°C, 30 secs. MIL-STD-750 (Method 2031)
Moisture Sensitivity Level	85%RH, +85°C, 168 hrs., 3 reflow cycles (+260°C Peak). JEDEC-J-STD-020, Level 1

Part Numbering

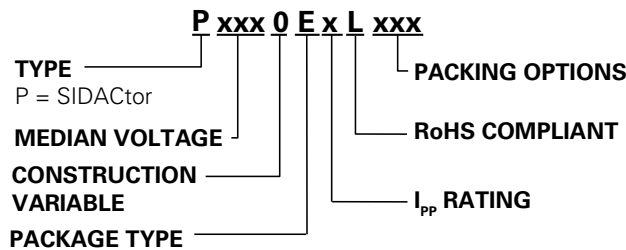

Part Marking

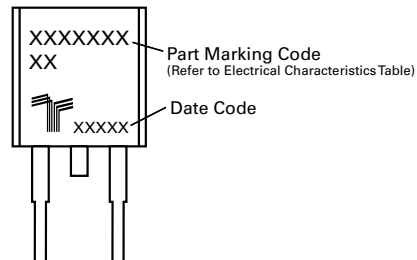

Packing Options

Package Type	Description	Packing Options Quantity	Added Suffix	Lead Spacing	Industry Standard
E	TO-92 Tape and Reel Pack	2000	RP1	0.1 inch (2.54mm)	EIA-481-D
	TO-92 Ammo Pack		RP2	0.2 inch (5.08mm)	
	TO-92 Bulk Pack		AP		EIA-468-B
			N/A		N/A

Dimensions — TO-92

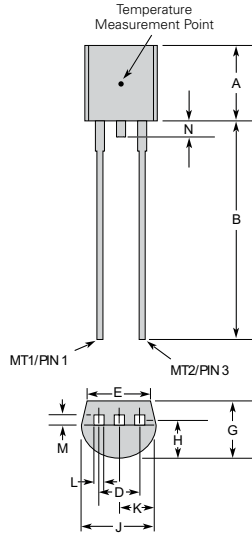

	Inches		Millimeters	
	Min	Max	Min	Max
A	0.176	0.196	4.47	4.98
B	0.500		12.70	
D	0.095	0.105	2.41	2.67
E	0.150		3.81	
G	0.135	0.145	3.43	3.68
H	0.088	0.096	2.23	2.44
J	0.176	0.186	4.47	4.73
K	0.088	0.096	2.23	2.44
L	0.013	0.019	0.33	0.48
M	0.013	0.017	0.33	0.43
N		0.60		1.52

All leads are insulated from case. Case is electrically non-conductive. (Rated at 1600 V_{(AC) RMS} for one minute from leads to case over the operating temperature range.)

Mold flash shall not exceed 0.13 mm per side.

The TO-92 is designed to meet mechanical standards as set forth in JEDEC publication number 95.

Ammo Pack Specification — TO-92

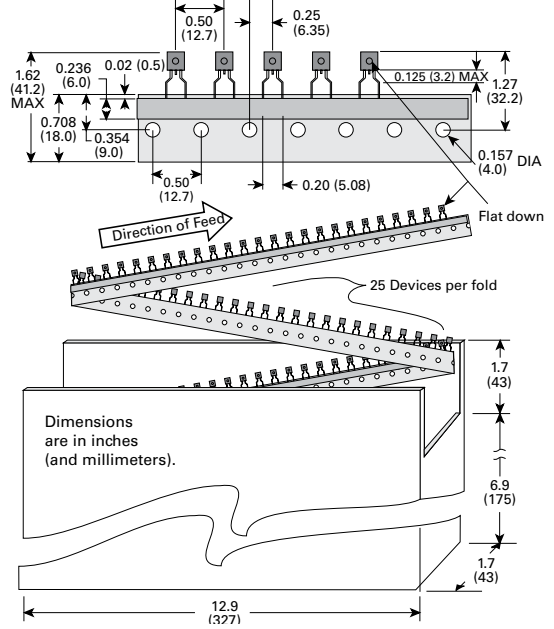

Tape and Reel Specification — TO-92

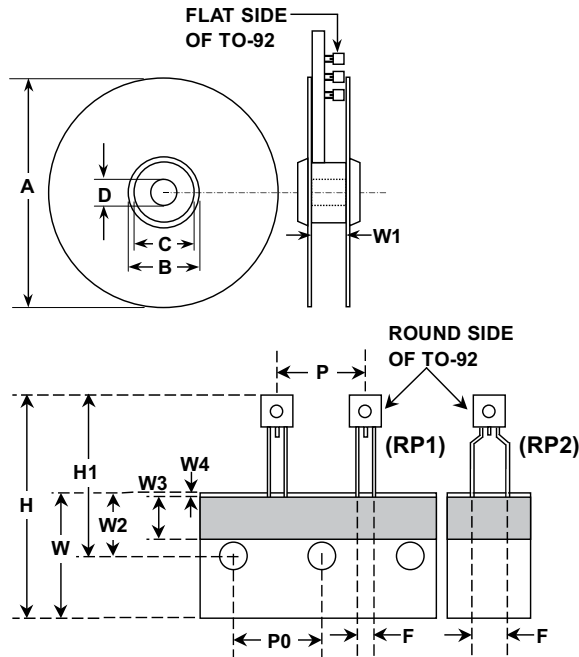

Dimensions	Inches		Millimeters	
	Min	Max	Min	Max
A	N/A	14.173	N/A	360.0
B	4.016	N/A	102.0	N/A
C	3.386	N/A	86.0	N/A
D	0.795	N/A	20.2	N/A
W1	1.181	1.968	30.0	50.0
P	0.496	0.504	12.60	12.80
P0	0.498	0.502	12.65	12.75
F(for RP1)	0.090	0.110	2.29	2.80
F(for RP2)	0.182	0.244	4.63	6.19
H	N/A	1.673	N/A	42.50
H1	N/A	1.270	N/A	32.26
W	0.674	0.763	17.12	19.38
W2	0.354	0.370	8.25	9.75
W3	0.236	N/A	6.00	N/A
W4	0.020	N/A	0.50	N/A