

DATA SHEET

# SMP1352-040LF: 0402 Surface Mount PIN Diode

## Applications

- WLAN, WiMAX, cellular handsets
- Cellular infrastructure
- RFID readers
- Test instruments
- High isolation switches
- Series diode switches

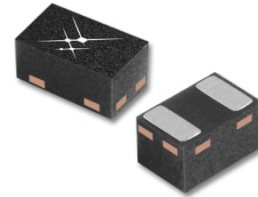

## Features

- Very low parasitic inductance and capacitance
- Low-thermal impedance
- Industry-standard 0402 footprint
- Packages rated MSL1, 260 °C per JEDEC J-STD-020

**NEW**



Skyworks Green™ products are RoHS (Restriction of Hazardous Substances)-compliant, conform to the EIA/EICTA/JEITA Joint Industry Guide (JIG) Level A guidelines, are halogen free according to IEC-61249-2-21, and contain <1,000 ppm antimony trioxide in polymeric materials.

## Description

The SMP1352-040LF is a plastic packaged, surface mountable PIN diode designed for high volume switch applications from 10 MHz to beyond 2 GHz. The low capacitance of this diode (0.25 pF) combined with its low resistance (1.0 Ω typical at 100 mA) make the SMP1352-040LF particularly well suited for high-isolation, series-connected PIN diode switches in battery-operated circuits.

The SMP1352-040LF is also available in a variety of plastic packages including an SOD-23 (SMP1352-011LF) and the small footprint SC-79.

Design information for high power switches may be found in the Skyworks Application Note, *Design With PIN Diodes* (document number 200312).

**Table 1. SMP1352-040LF Absolute Maximum Ratings**

Parameter	Symbol	Minimum	Maximum	Units
Reverse voltage	V <sub>R</sub>		200	V
Forward current	I <sub>F</sub>		150	mA
Dissipated power @ 25 °C	P <sub>D</sub>		750	mW
Solder interface temperature	T <sub>S</sub>	-40	+85	°C
Storage temperature	T <sub>STG</sub>	-65	+150	°C
Junction temperature	T <sub>J</sub>		+175	°C

**Note:** Exposure to maximum rating conditions for extended periods may reduce device reliability. There is no damage to device with only one parameter set at the limit and all other parameters set at or below their nominal value. Exceeding any of the limits listed here may result in permanent damage to the device.

**CAUTION:** Although this device is designed to be as robust as possible, Electrostatic Discharge (ESD) can damage this device. This device must be protected at all times from ESD. Static charges may easily produce potentials of several kilovolts on the human body or equipment, which can discharge without detection. Industry-standard ESD precautions should be used at all times. The SMP1352-040LF is rated as a Human Body Model (HBM) ESD Class 1B device.

**Table 2. SMP1352-040LF Electrical Specifications (Note 1)**

(T<sub>S</sub> = +25 °C, Unless Otherwise Noted)

Parameter	Symbol	Test Condition	Min	Typical	Max	Units
Reverse current (Note 2)	I <sub>R</sub>	V <sub>R</sub> = 200 V			10	μA
Total capacitance	C <sub>T</sub>	V <sub>R</sub> = 20 V, f = 1 MHz			0.3	pF
Series resistance	R <sub>S</sub>	I <sub>F</sub> = 1 mA, f = 100 MHz		11	15	Ω
		I <sub>F</sub> = 10 mA, f = 100 MHz		2.00	2.80	Ω
		I <sub>F</sub> = 100 mA, f = 100 MHz		1.00	1.35	Ω
Forward voltage	V <sub>F</sub>	I <sub>F</sub> = 10 mA		0.8		V
Minority carrier lifetime	T <sub>L</sub>	I <sub>F</sub> = 10 mA		1		μs
I region width	W			50		μm

**Note 1:** Performance is guaranteed only under the conditions listed in this Table.

**Note 2:** It is not recommended to drive a PIN diode into avalanche breakdown. Permanent damage may result.

## Electrical and Mechanical Specifications

The absolute maximum ratings of the SMP1352-040LF are provided in Table 1. Electrical specifications are provided in Table 2.

Typical performance characteristics of the SMP1352-040LF are illustrated in Figures 1, 2, and 3.

## Package Dimensions

The PCB layout footprint for the SMP1352-040LF is provided in Figure 4. Typical case markings are shown in Figure 5. Package dimensions for the SMP1352-040LF are provided in Figure 6. Tape and reel dimensions are provided in Figure 7.

## Package and Handling Information

Instructions on the shipping container label regarding exposure to moisture after the container seal is broken must be followed. Otherwise, problems related to moisture absorption may occur when the part is subjected to high temperature during solder assembly.

The SMP1352-040LF is rated to Moisture Sensitivity Level 1 (MSL1) at 260 °C. It can be used for lead or lead-free soldering. For additional information, refer to the Skyworks Application Note, *Solder Reflow Information*, document number 200164

Care must be taken when attaching this product, whether it is done manually or in a production solder reflow environment. Production quantities of this product are shipped in a standard tape and reel format. For packaging details, refer to the Skyworks Application Note, *Discrete Devices and IC Switch/Attenuators Tape and Reel Package Orientation*, document number 200083.

### Typical Performance Characteristics

(Ts = 25 °C, Unless Otherwise Noted)

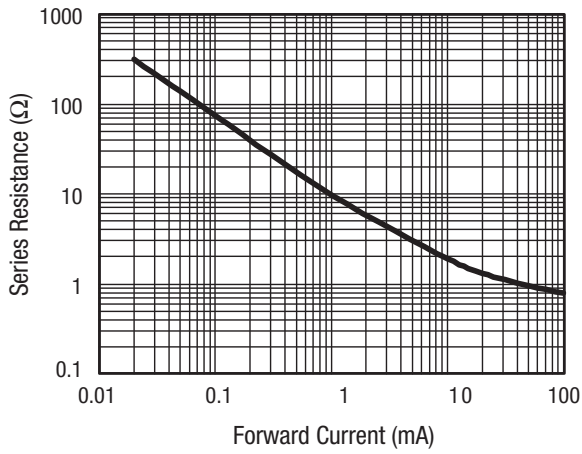

Figure 1. Series Resistance vs Current @ 100 MHz

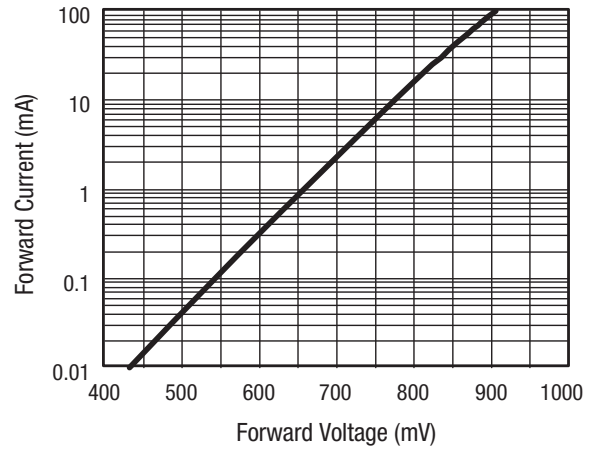

Figure 2. DC Characteristic

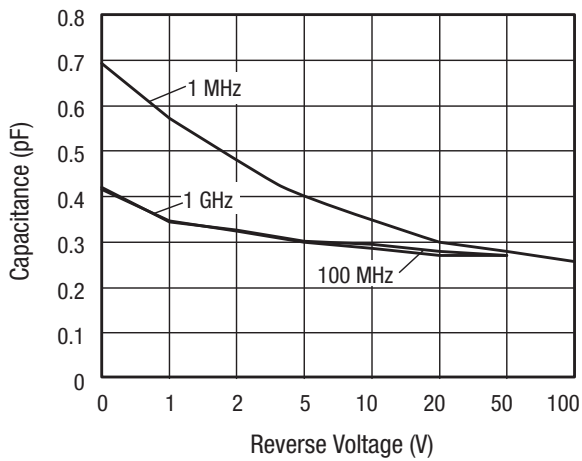
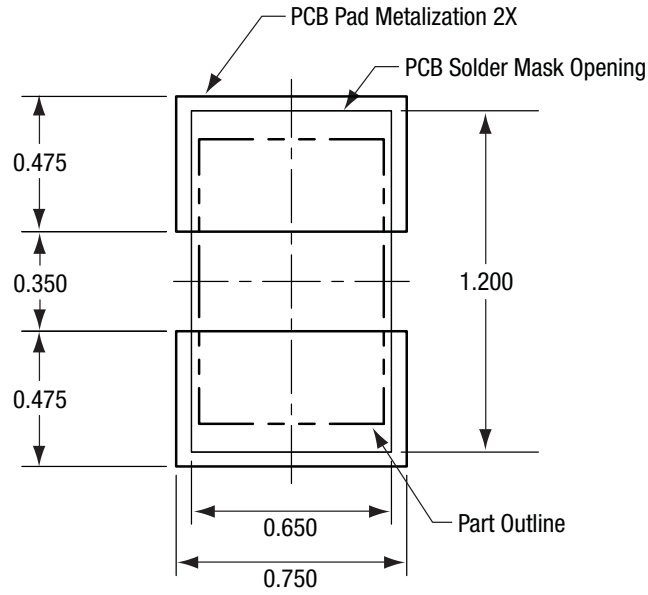

Figure 3. Capacitance vs Reverse Voltage (@ 1.0 MHz)



All measurements in millimeters

S1997

**Figure 4. SMP1352-040LF PCB Layout Footprint**

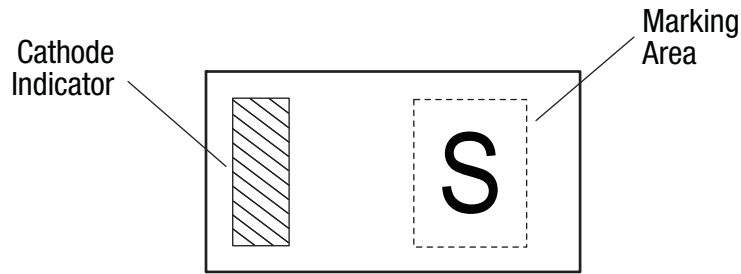

**Figure 5. Typical Case Markings (Top View)**

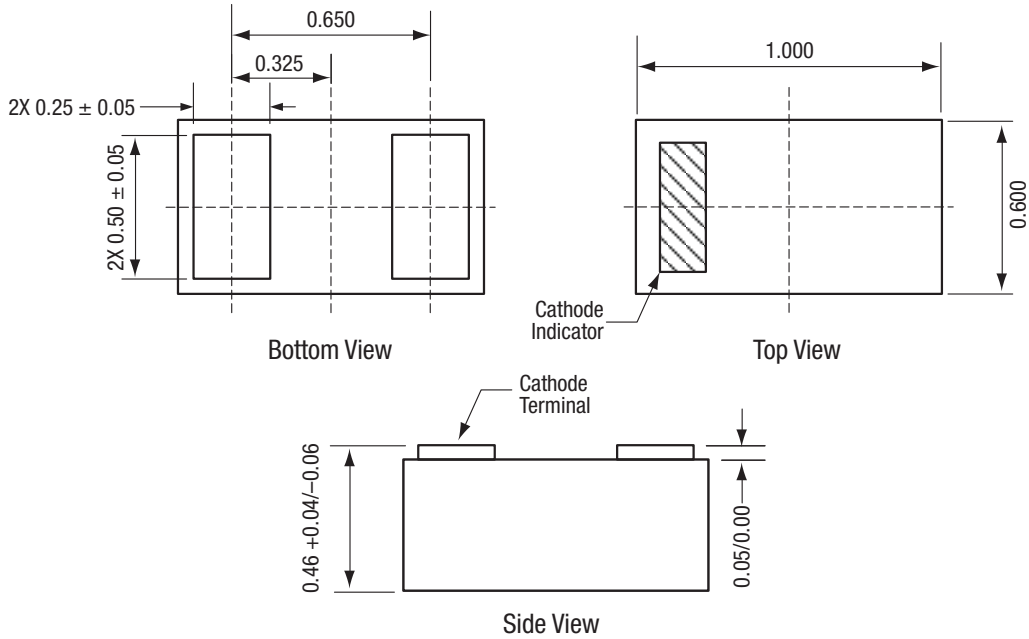

All dimensions in millimeters

S1892

Figure 6. SMP1352-040LF Package Dimensions

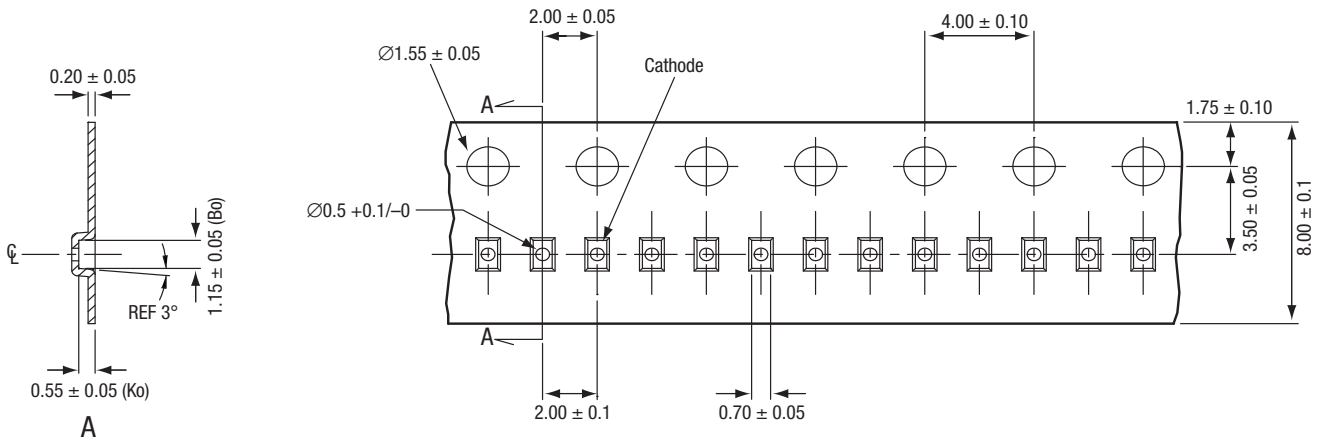

Notes:

1. Cumulative tolerance of 10 sprocket holes is  $\pm 0.20$  mm.
2. All dimensions are in millimeters

S1922

Figure 7. SMP1352-040LF Tape and Reel Dimensions

## Ordering Information

Model Name	Manufacturing Part Number
SMP1352-040LF Surface Mount PIN Diode	SMP1352-040LF

Copyright © 2010 Skyworks Solutions, Inc. All Rights Reserved.

Information in this document is provided in connection with Skyworks Solutions, Inc. (“Skyworks”) products or services. These materials, including the information contained herein, are provided by Skyworks as a service to its customers and may be used for informational purposes only by the customer. Skyworks assumes no responsibility for errors or omissions in these materials or the information contained herein. Skyworks may change its documentation, products, services, specifications or product descriptions at any time, without notice. Skyworks makes no commitment to update the materials or information and shall have no responsibility whatsoever for conflicts, incompatibilities, or other difficulties arising from any future changes.

No license, whether express, implied, by estoppel or otherwise, is granted to any intellectual property rights by this document. Skyworks assumes no liability for any materials, products or information provided hereunder, including the sale, distribution, reproduction or use of Skyworks products, information or materials, except as may be provided in Skyworks Terms and Conditions of Sale.

THE MATERIALS, PRODUCTS AND INFORMATION ARE PROVIDED “AS IS” WITHOUT WARRANTY OF ANY KIND, WHETHER EXPRESS, IMPLIED, STATUTORY, OR OTHERWISE, INCLUDING FITNESS FOR A PARTICULAR PURPOSE OR USE, MERCHANTABILITY, PERFORMANCE, QUALITY OR NON-INFRINGEMENT OF ANY INTELLECTUAL PROPERTY RIGHT; ALL SUCH WARRANTIES ARE HEREBY EXPRESSLY DISCLAIMED. SKYWORKS DOES NOT WARRANT THE ACCURACY OR COMPLETENESS OF THE INFORMATION, TEXT, GRAPHICS OR OTHER ITEMS CONTAINED WITHIN THESE MATERIALS. SKYWORKS SHALL NOT BE LIABLE FOR ANY DAMAGES, INCLUDING BUT NOT LIMITED TO ANY SPECIAL, INDIRECT, INCIDENTAL, STATUTORY, OR CONSEQUENTIAL DAMAGES, INCLUDING WITHOUT LIMITATION, LOST REVENUES OR LOST PROFITS THAT MAY RESULT FROM THE USE OF THE MATERIALS OR INFORMATION, WHETHER OR NOT THE RECIPIENT OF MATERIALS HAS BEEN ADVISED OF THE POSSIBILITY OF SUCH DAMAGE.

Skyworks products are not intended for use in medical, lifesaving or life-sustaining applications, or other equipment in which the failure of the Skyworks products could lead to personal injury, death, physical or environmental damage. Skyworks customers using or selling Skyworks products for use in such applications do so at their own risk and agree to fully indemnify Skyworks for any damages resulting from such improper use or sale.

Customers are responsible for their products and applications using Skyworks products, which may deviate from published specifications as a result of design defects, errors, or operation of products outside of published parameters or design specifications. Customers should include design and operating safeguards to minimize these and other risks. Skyworks assumes no liability for applications assistance, customer product design, or damage to any equipment resulting from the use of Skyworks products outside of stated published specifications or parameters.

Skyworks, the Skyworks symbol, and “Breakthrough Simplicity” are trademarks or registered trademarks of Skyworks Solutions, Inc., in the United States and other countries. Third-party brands and names are for identification purposes only, and are the property of their respective owners. Additional information, including relevant terms and conditions, posted at [www.skyworksinc.com](http://www.skyworksinc.com), are incorporated by reference.